

Varenummer: 206532M522ST  
Beskrivelse: E+G Fingerskrue  
GN 653.2-M5-22-ST

## Mål

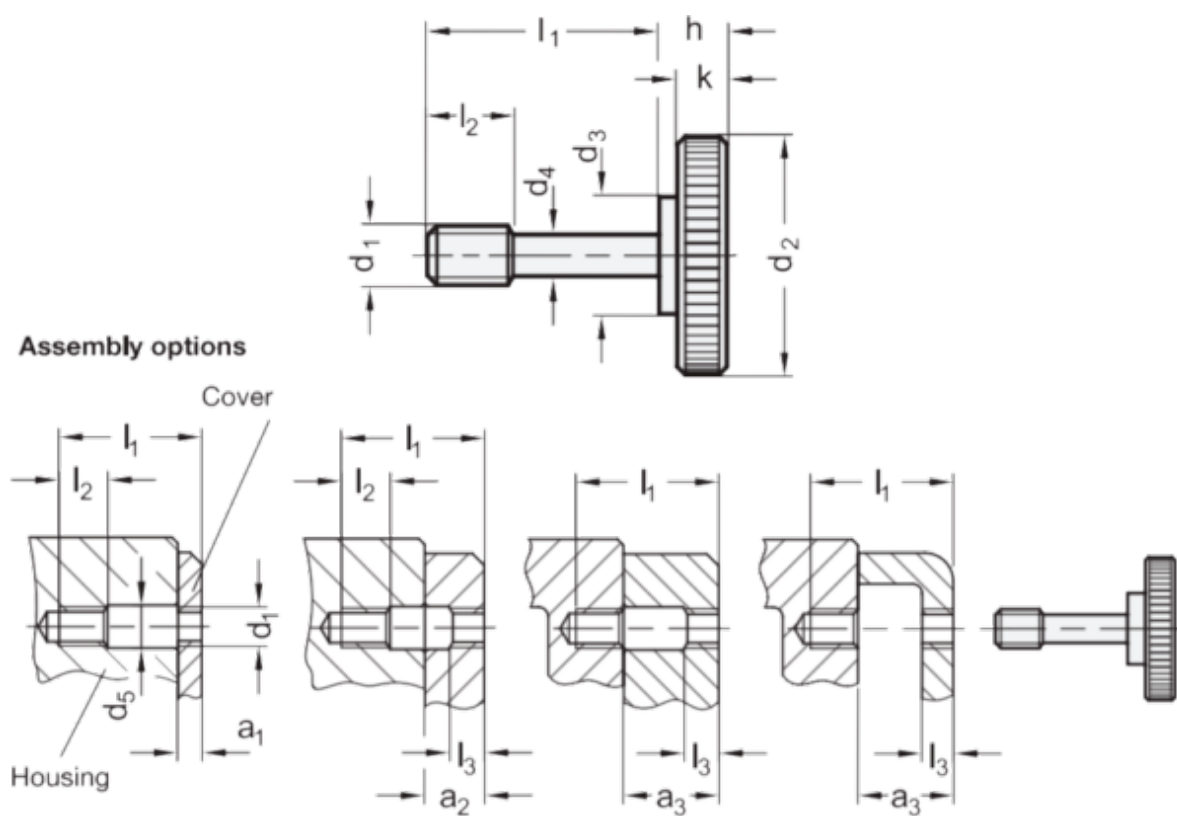

$d_1 = M5$   
 $d_2 = 20$   
 $d_3 = 10$   
 $d_4 = 4$   
 $h = 6.5$   
 $k = 4$   
 $l_1 = 22$